

**ENOCH**

PACKAGING SUPPLY

**PRODUCT  
BROCHURE**

**FOOD PACKAGING EXPERT**

FOCUSED ON SPECIAL PROCESSES SINCE 2010

ENOCH PACKAGING SUPPLY

PAPER PRODUCTS · PLASTIC PRODUCTS · SPECIAL PROCESSES

VOL. 01

EST. 2026

# **“EVERYTHING IS PACKAGING”**

---

**EVERYTHING A USER CAN REACH AND PERCEIVE IS PACKAGING**

Every touchpoint is a brand expression — every detail is designed to matter.

THE WHOLE PROCESS IS MADE BY OURSELVES

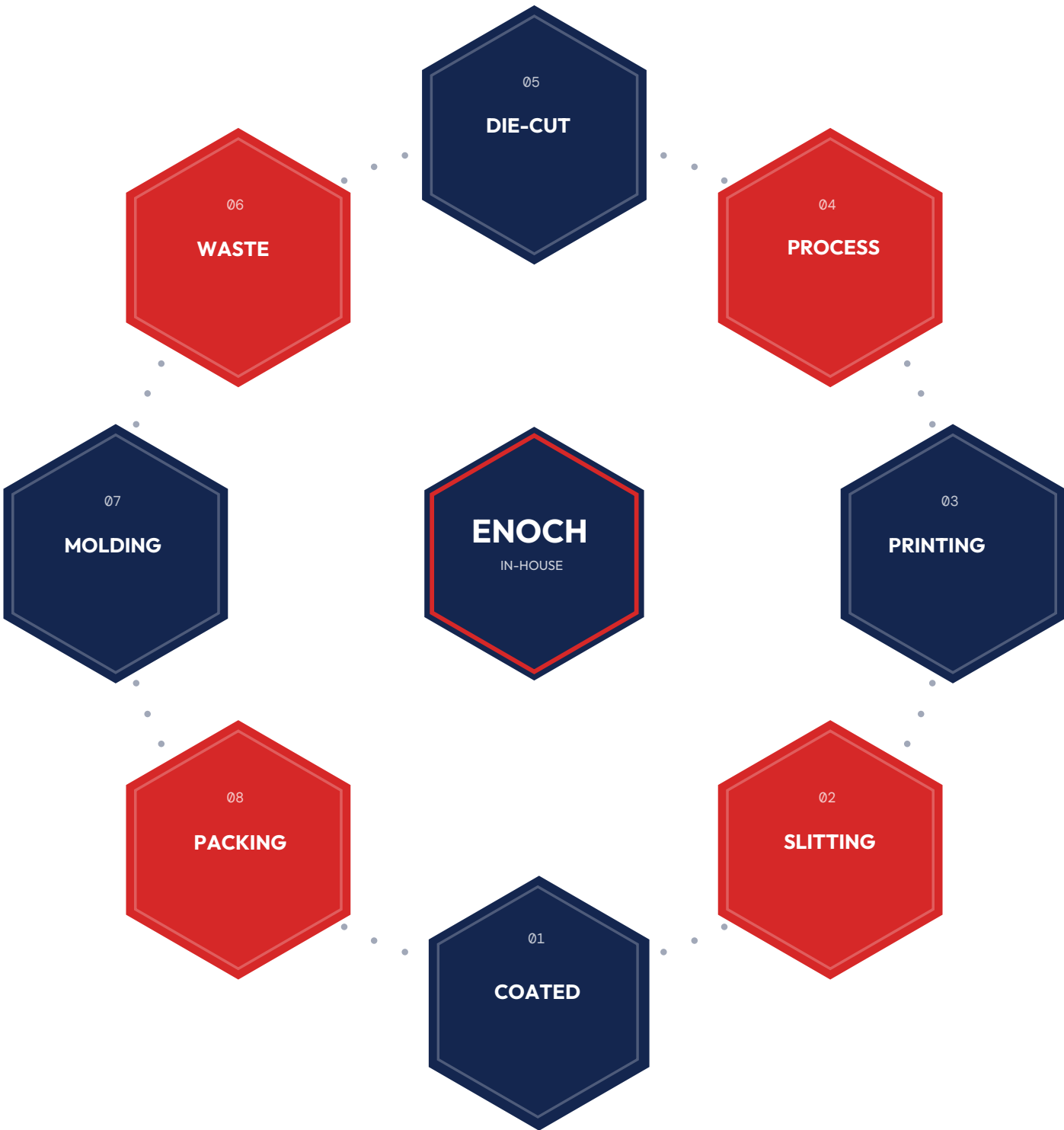

FROM RAW MATERIALS TO FINISHED GOODS

EVERY STEP IS PERFORMED IN-HOUSE BY OUR OWN TEAM



FOOD PACKAGING EXPERT · FOCUSING ON SPECIAL PROCESSES

# ENOCH



## CUP SERIES

SECTION 01 OF 07

**WE CAN DO ALL THE STYLES ON THE MARKET**

ANY TECHNIQUE · ANY VOLUME · ANY BRAND

# PRODUCT PACKAGING FLOW



## PICK A CUP

STEP 1

- .....
- HOT CUP
  - IN-MOLD LABEL
  - BOTTLE
  - PET
  - SQUARE



## CHOOSE A COVER

STEP 2

- .....
- INJECTION
  - DOME
  - SWIVEL
  - SPLIT
  - FLIP



## CUP SLEEVE

STEP 3

- .....
- CARD BUCKLE
  - DOUBLE LAYER
  - ALIEN SHAPE



## SELECT A STRAW

STEP 4

- .....
- PAPER
  - PLA
  - WRAPPED PP
  - BAMBOO



## SELECT BAG

STEP 5

- .....
- PAPER BAG
  - PLASTIC
  - CARRIER
  - BOX
  - INSULATED



## CHOOSE STICKER

STEP 6

- .....
- LABEL
  - RECEIPT
  - REMINDER
  - CREATIVE



## OTHER

STEP 7

- .....
- LEAK-PROOF
  - SEAL FILM
  - NAPKIN
  - CUTLERY

# HOT DRINK CUPS

12 STANDARD STYLES · CUSTOMIZABLE



SINGLE-COATED



DOUBLE-COATED



TEXTURED



10A HOLLOW



12A HOLLOW



16A HOLLOW



BRUSHED GOLD



BRUSHED SILVER



CUP-IN-CUP



CORRUGATED



22A HOLLOW



DIAGONAL

NOTE: ALL CUPS COMPATIBLE WITH SEAL FILM (EXCEPT PET & PLA)

**SINGLE-COATED · SIZES**

SINGLE-LAYER / SINGLE-COATED PAPER CUPS SIZE GUIDE

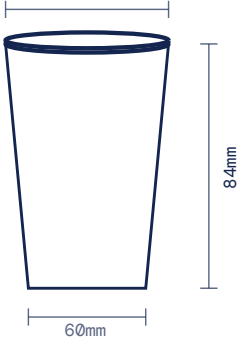
**1**  
**8OZ**  
 90-8OZ  
 90mm  
  
 84mm  
 60mm  
**300ml** **1000/BOX**  
 WT 7g 7.5kg

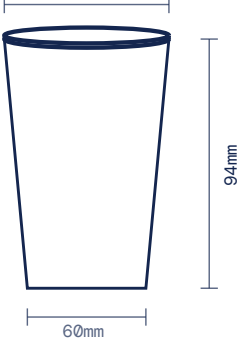
**2**  
**10OZ**  
 90-10OZ  
 90mm  
  
 94mm  
 60mm  
**330ml** **1000/BOX**  
 WT 8g 8.5kg

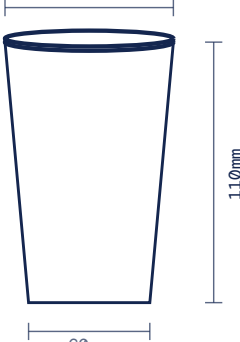
**3**  
**12OZ**  
 90-12OZ  
 90mm  
  
 110mm  
 60mm  
**400ml** **1000/BOX**  
 WT 10g 11kg

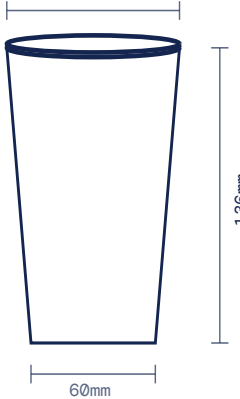
**4**  
**16OZ**  
 90-16OZ  
 90mm  
  
 136mm  
 60mm  
**500ml** **1000/BOX**  
 WT 12.5g 13kg

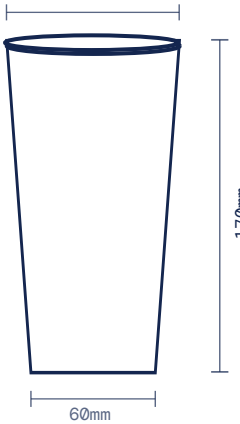
**5**  
**22OZ**  
 90-22OZ  
 90mm  
  
 170mm  
 60mm  
**700ml** **1000/BOX**  
 WT 15g 16kg

● **DOUBLE-COATED · SIZES**

SINGLE-LAYER / DOUBLE-COATED PAPER CUPS SIZE GUIDE

**1**  
**8OZ**  
 90-8OZ  
 90mm  
  
 84mm  
 60mm  
**300ml** **1000/BOX**  
 WT 7g 7.5kg

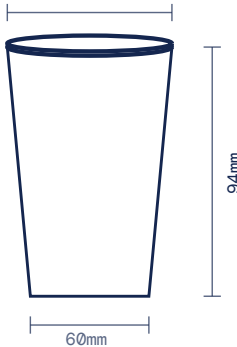
**2**  
**10OZ**  
 90-10OZ  
 90mm  
  
 94mm  
 60mm  
**330ml** **1000/BOX**  
 WT 8g 8.5kg

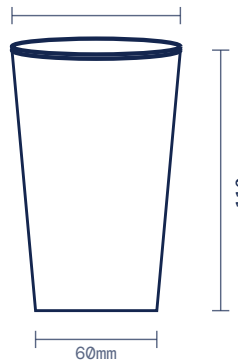
**3**  
**12OZ**  
 90-12OZ  
 90mm  
  
 110mm  
 60mm  
**400ml** **1000/BOX**  
 WT 10g 11kg

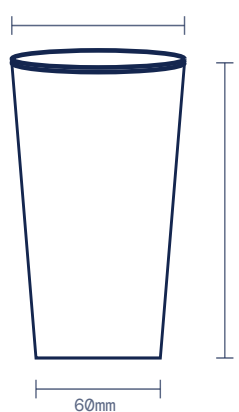
**4**  
**16OZ**  
 90-16OZ  
 90mm  
  
 136mm  
 60mm  
**500ml** **1000/BOX**  
 WT 12.5g 13kg

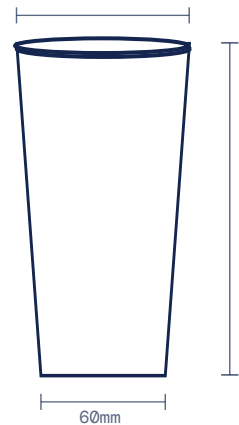
**5**  
**22OZ**  
 90-22OZ  
 90mm  
  
 170mm  
 60mm  
**700ml** **1000/BOX**  
 WT 15g 16kg

**HOLLOW CUPS · SIZES**

HOLLOW PAPER CUPS SIZE GUIDE

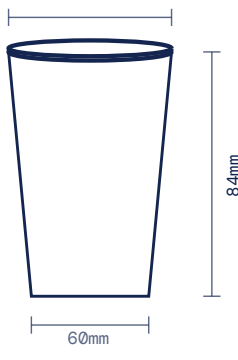
**1**  
**8OZ**  
 90-8OZ  
 90mm  
  
 84mm  
 60mm  
**300ml** **1000/BOX**  
 WT 7g 7.5kg

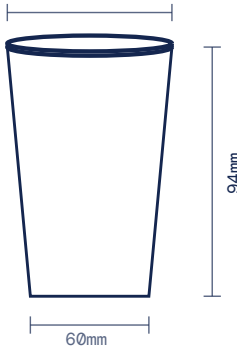
**2**  
**10OZ**  
 90-10OZ  
 90mm  
  
 94mm  
 60mm  
**330ml** **1000/BOX**  
 WT 8g 8.5kg

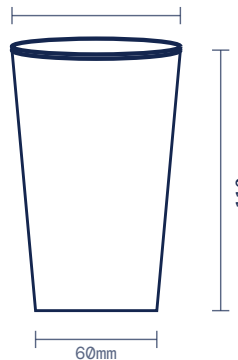
**3**  
**12OZ**  
 90-12OZ  
 90mm  
  
 110mm  
 60mm  
**400ml** **1000/BOX**  
 WT 10g 11kg

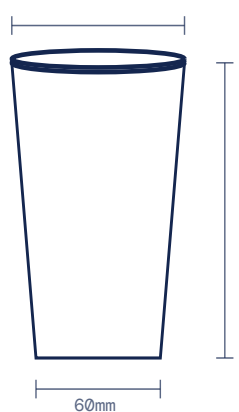
**4**  
**16OZ**  
 90-16OZ  
 90mm  
  
 136mm  
 60mm  
**500ml** **1000/BOX**  
 WT 12.5g 13kg

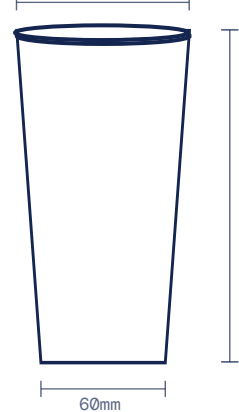
**5**  
**22OZ**  
 90-22OZ  
 90mm  
  
 170mm  
 60mm  
**700ml** **1000/BOX**  
 WT 15g 16kg

HOT CUP · APPLICATIONS

REAL-WORLD BRAND IMPLEMENTATIONS

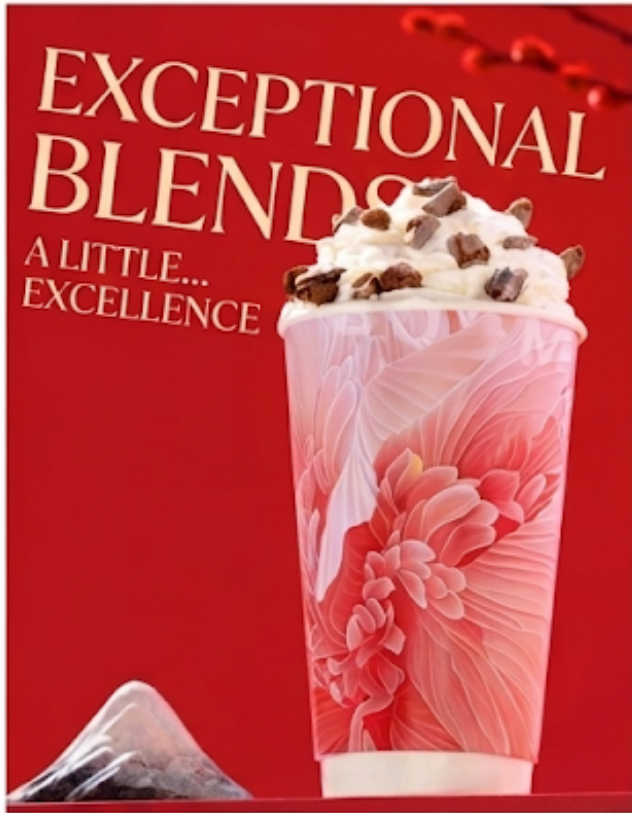

# SPECIAL TECHNIQUES

INDUSTRY-LEADING PROCESS APPLICATIONS



SILK SCREEN



SPOT UV

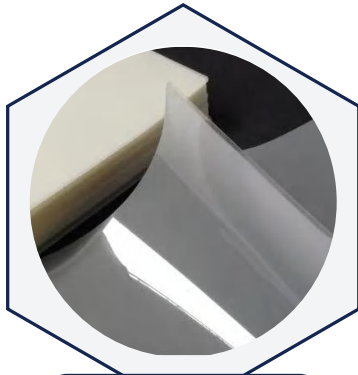

LAMINATION

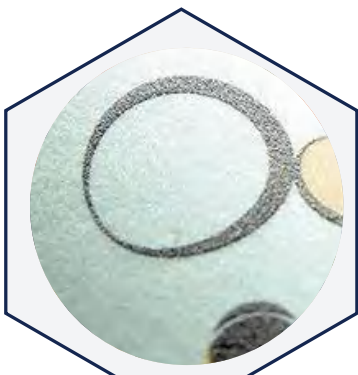

FOAMING

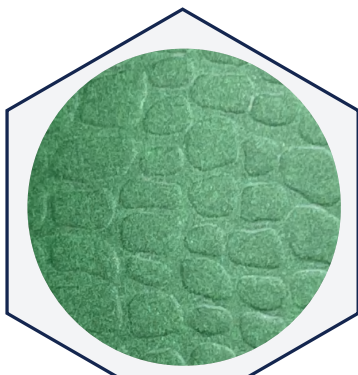

EMBOSSSED



CONVEX

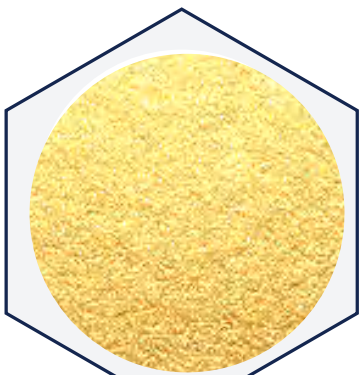

BRONZING

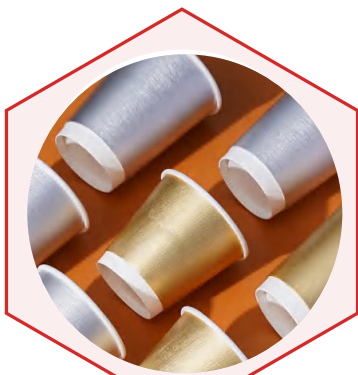

COLD STAMP



TRANSFER

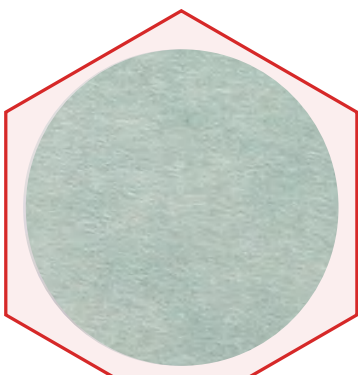

FLOCKING



HOLLOW

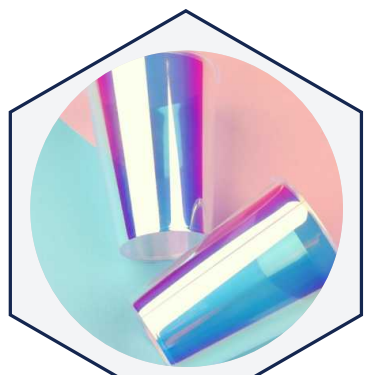

MORE

ALL INDUSTRY TECHNIQUES AVAILABLE · CONTACT CUSTOMER SERVICE

● SPECIAL TECHNIQUES · IN USE

TECHNIQUE DEMONSTRATIONS IN BRAND CONTEXT



● ALL MARKET TECHNIQUES CUSTOMIZABLE · CONTACT CUSTOMER SERVICE

**COLD DRINK CUPS**

ALL SIZES CUSTOMIZABLE ON REQUEST



**INJECTION**



**PET**



**SQUARE**



**U-SHAPED**



**IN-FILM**



**BOTTLE**

**COLD DRINK CUP SIZE GUIDE**

**INJECTION CUP**

80mm · 90mm · 95mm TOP DIAMETERS

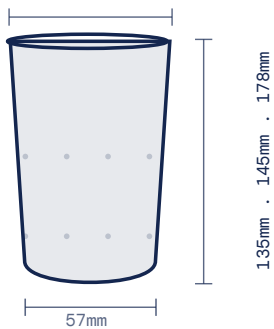

**500/520/700ml**

WT 22/17/15g

**500/BOX**

11.7/9.2/8.5kg

**PET CUP**

95mm · TOP DIAMETERS

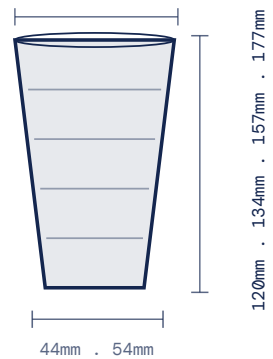

**500/700ml**

WT 12/10g

**1000/BOX**

12.7/10.5kg

# COLD CUP · APPLICATIONS

BUBBLE TEA / ICED COFFEE / SODA APPLICATIONS





PAPER CUP MANUFACTURING EXPERT · FOCUSING ON SPECIAL PROCESSES

# ENOCH



## LID SERIES

SECTION 02 OF 07

**WE CAN DO ALL THE STYLES ON THE MARKET**

ANY TECHNIQUE · ANY VOLUME · ANY BRAND

# LID SERIES

15 STANDARD LIDS · CUSTOM SHAPES AVAILABLE

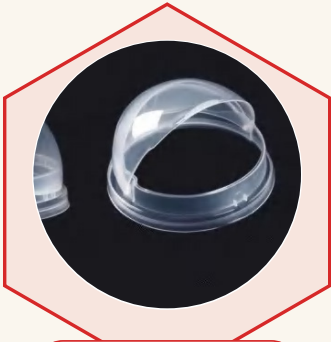

90° ROTATE DOME



SEMI-CIRCULAR



PANDA LID



SWIVEL LID



SPLIT HOT LID



FLAP LEAK-PROOF



DIRECT DRINK FLIP



INJECTION/SIAMESE



SPLIT LID



PET SNAP LID



PET DOUBLE HOLE



PET DIRECT DRINK

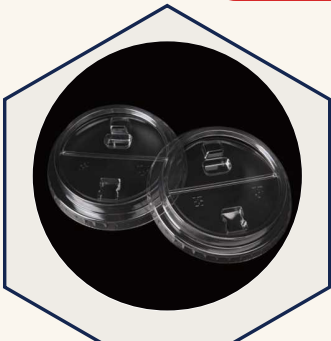

CLAMSHELL



FLAT LID



HIGH COVER

# LID · APPLICATIONS

LID IMPLEMENTATIONS · SEALED FRESHNESS





PAPER CUP MANUFACTURING EXPERT · FOCUSING ON SPECIAL PROCESSES

# ENOCH



## CUP SLEEVES

SECTION 03 OF 07

**WE CAN DO ALL THE STYLES ON THE MARKET**

ANY TECHNIQUE · ANY VOLUME · ANY BRAND

# CUP SLEEVES

3 SLEEVE STYLES · GRIP + BRANDING

## 01

### CARD BUCKLE

TYPE 01

DETACHABLE · REUSABLE · BRANDED CLIP

SKU-SLV-01



## 02

### DOUBLE LAYER

TYPE 02

DOUBLE INSULATION · ANTI-SCALD · FOR HOT DRINKS

SKU-SLV-02



## 03

### ALIEN SHAPE

TYPE 03

CUSTOM SHAPE · HOLIDAY THEMES · CREATIVE MARKETING

SKU-SLV-03



# SLEEVE · APPLICATIONS

BRANDED SLEEVES IN THE WILD · SEASONAL CAMPAIGNS





PAPER CUP MANUFACTURING EXPERT · FOCUSING ON SPECIAL PROCESSES

# ENOCH



# STRAW SERIES

SECTION 04 OF 07

**WE CAN DO ALL THE STYLES ON THE MARKET**

ANY TECHNIQUE · ANY VOLUME · ANY BRAND

# ● STRAW SERIES

5 STRAW TYPES · ECO OPTIONS AVAILABLE



# ● STRAW · APPLICATIONS





PAPER CUP MANUFACTURING EXPERT · FOCUSING ON SPECIAL PROCESSES

# ENOCH

# 05

# PACKAGING BAGS

SECTION 05 OF 07

**WE CAN DO ALL THE STYLES ON THE MARKET**

ANY TECHNIQUE · ANY VOLUME · ANY BRAND

● **PACKAGING BAGS**

6 BAG SOLUTIONS · DELIVERY · DINE-IN · GIFT

**01**



**PAPER BAGS**

**02**



**PLASTIC BAGS**

**03**



**CUP CARRIER**

**04**



**TAKEAWAY BOX**

**05**



**INSULATED BAG**

**06**



**CUP HOLDER**

# BAGS · APPLICATIONS

CUSTOM BRANDED PACKAGING · IN THE FIELD





PAPER CUP MANUFACTURING EXPERT · FOCUSING ON SPECIAL PROCESSES

# ENOCH



# STICKERS

SECTION 06 OF 07

**WE CAN DO ALL THE STYLES ON THE MARKET**

ANY TECHNIQUE · ANY VOLUME · ANY BRAND

## ● STICKERS

6 STICKER TYPES · LABELS · MARKETING · SAFETY

01

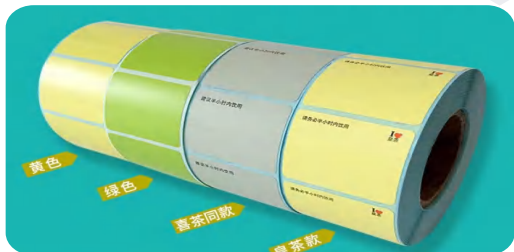

LABEL PAPER

02



RECEIPT PAPER

03



TAKEAWAY REMINDER

04



CREATIVE STICKERS

05



LID REMINDER

06



EXPIRATION DATE

# ● STICKERS · APPLICATIONS

LABELS IN THE WILD · BRAND IDENTITY · PACKAGING





PAPER CUP MANUFACTURING EXPERT · FOCUSING ON SPECIAL PROCESSES

# ENOCH



# OTHER

SECTION 07 OF 07

**WE CAN DO ALL THE STYLES ON THE MARKET**

ANY TECHNIQUE · ANY VOLUME · ANY BRAND

OTHER · ACCESSORIES

ACCESSORIES · LEAK-PROOF · SEAL FILM · CUTLERY · NAPKINS



IN USE

OF PRACTICAL APPLICATION





# BEAUTIFUL

SO YOU WANT TO DRINK IT



# DELICIOUS

SO CUSTOMERS COME BACK FOR MORE



**ENOCH MAKES PACKAGING THAT MAKES CUSTOMERS COME BACK**

YOUR BEVERAGE DESERVES PACKAGING THAT TELLS ITS STORY

# WHY CHOOSE US



FOUR REASONS THE WORLD TRUSTS ENOCH



## THE REAL SOURCE MANUFACTURER

OWN FACTORY · NO MIDDLEMAN

// FACTORY



## FULL PROCESS CONTROL

FROM BASE PAPER TO FINISHED PRODUCT

// PROCESS



## INTERNATIONAL · 55 COUNTRIES

EU/US STANDARDS · GLOBAL PARTNERS

// GLOBAL



## 20 YEARS OF FOCUS

DEEP EXPERTISE IN F&B PACKAGING

// EXPERIENCE



# CUSTOMIZATION PROCESS



STEP 01

## CONSULT CUSTOMER SERVICE

WhatsApp · Email · Inquiry Form



STEP 02

## DESIGN FINALIZED

Structure · Print · Process confirmed



STEP 03

## ORDER PRODUCTION

Own factory · Quality control throughout



STEP 04

## LOGISTICS TRACKING

Sea · Air · Land freight tracking



STEP 05

## AFTER-SALES SERVICE

Long-term partnership · Dedicated manager

**LET'S MAKE IT BOOM**

Enoch Packaging Supply · Global Sourcing Partner

